

## ACCESSIBLE POINTS IN THE JULIA SETS OF STABLE EXPONENTIALS

RANJIT BHATTACHARJEE, ROBERT L. DEVANEY<sup>1</sup>, R. E. LEE DEVILLE,  
KREŠIMIR JOSIĆ, MONICA MORENO-ROCHA

Department of Mathematics and Statistics  
Boston University  
111 Cummington St.  
Boston, MA 02215

(Communicated by ???)

**ABSTRACT.** In this paper we consider the question of accessibility of points in the Julia sets of complex exponential functions in the case where the exponential admits an attracting cycle. In the case of an attracting fixed point it is known that the Julia set is a Cantor bouquet and that the only points accessible from the basin are the endpoints of the bouquet. In case the cycle has period two or greater, there are many more restrictions on which points in the Julia set are accessible. In this paper we give precise conditions for a point to be accessible in the periodic point case in terms of the kneading sequence for the cycle.

**1. Introduction.** Our goal in this paper is to investigate the set of accessible points in the Julia sets of complex exponentials  $E_\lambda(z) = \lambda e^z$  for which  $E_\lambda$  has an attracting cycle of period two or larger. We denote the Julia set by  $J(E_\lambda)$ . In this case it is known that  $J(E_\lambda)$  is the complement of the basin of attraction of the attracting cycle and that this basin is a countable union of open sets whose union is dense in the plane. A point  $z_0$  in  $J(E_\lambda)$  is *accessible* if there is a continuous curve  $\gamma : [0, \infty) \rightarrow \mathbb{C}$  for which  $\gamma(t)$  lies in the basin of attraction for all  $t$  and

$$\lim_{t \rightarrow \infty} \gamma(t) = z_0.$$

Note that such a curve must therefore lie in a single component of the basin.

The question of accessibility of points in the Julia set was first discussed in [12] in the case where  $\lambda \in \mathbb{R}$  and  $E_\lambda$  has an attracting fixed point. In this case it is known (see [1]) that the Julia set of  $E_\lambda$  is a *Cantor bouquet*. We will describe this structure below in more detail. Roughly speaking, a Cantor bouquet has the property that each point in the Julia set lies on a curve or “hair” which extends to  $\infty$  in the right half plane and which has a distinguished endpoint. All points, except possibly the endpoint, have orbits that tend to  $\infty$ . Consequently, the set of repelling periodic points must lie on the endpoints of these curves. Since repelling periodic points are

---

1991 *Mathematics Subject Classification.* 37F50.

*Key words and phrases.* Accessibility, Cantor Bouquets, Julia Sets.

<sup>1</sup>Please address all correspondence to Robert L. Devaney, Department of Mathematics, Boston University, Boston MA 02215, or email bob@bu.edu.

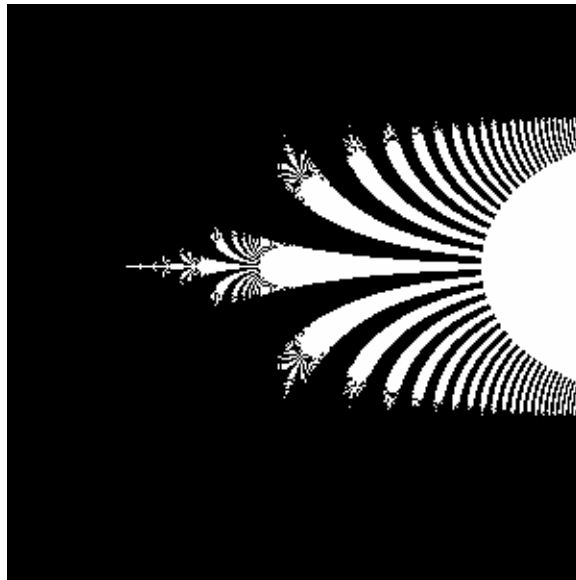
FIGURE 1. The Julia set for  $\lambda = 1/e$ .

dense in  $J(E_\lambda)$ , it follows that the set of endpoints of these curves must also be dense. Moreover, it is known that the Cantor bouquet is nowhere locally connected.

In Figure 1, we display the Julia set when  $\lambda = 1/e$ . When  $0 < \lambda < 1/e$ ,  $E_\lambda$  has an attracting fixed point with a similar Julia set as the one for  $\lambda = 1/e$ . The basin of attraction of this fixed point (the complement of the Julia set) is shown in black. The Cantor bouquet is displayed in white. In this figure, it appears that the Julia set contains open sets. In reality,  $J(E_\lambda)$  is an uncountable collection of disjoint curves. These curves are packed closely together and it is known [24] that the Hausdorff dimension of this set is 2.

In [12] it is shown that the set of accessible points in this Julia set are precisely the set of endpoints together with the point at  $\infty$ . Thus, all points on the curves (with the exception of the endpoints) are inaccessible.

In the case of an attracting cycle with period greater than one, the situation is different. In this case the Julia set is a Cantor bouquet with “pinchings.” By this we mean that there are infinitely many points in  $J(E_\lambda)$  that lie at the endpoint of two or more hairs. These pinchings or attachments have been described in [6] and [13].

For example, in Figure 2, we display the Julia set when  $\lambda = 5 + i\pi$ . It is easy to see that this exponential has an attracting cycle of period 3. In this case it appears that there are triplets of hairs that are attached at certain points in the plane. As another example, in Figure 3, we display the Julia set when  $\lambda = 10 + 3\pi i$ . This map also has an attracting cycle of period 3. Note that a larger number of hairs now seem to be attached.

Because of these attachments, the set of accessible points in  $J(E_\lambda)$  is quite different in the cycle case. It is no longer the case that all endpoints are accessible; rather, only very special endpoints (and  $\infty$ ) are accessible. Our goal in this paper is

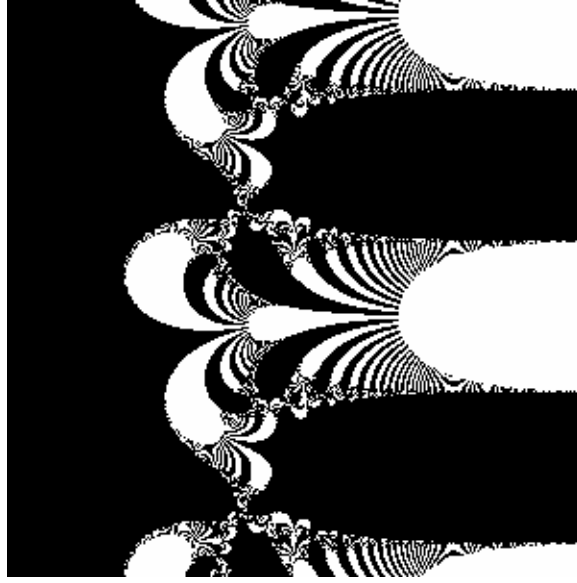
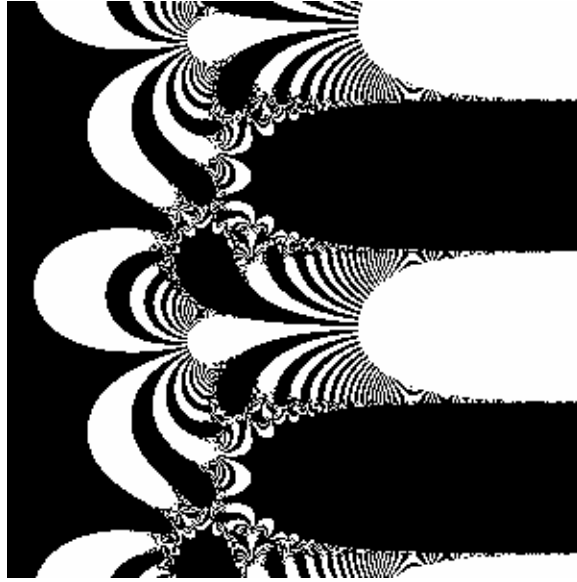
FIGURE 2. The Julia set for  $\lambda = 5 + \pi i$ .FIGURE 3. The Julia set for  $\lambda = 10 + 3\pi i$ .

to describe precisely this set of accessible points. This in turn yields a good picture of the topology of this set.

To describe the set of accessible points, we make use of the *kneading sequence* for  $E_\lambda$  as introduced in [6] and [13]. We recall this construction in Section 3. We review the definition of a *straight brush* and several characteristics of a Cantor bouquet

in Section 4. In [8] it is shown that points in  $J(E_\lambda)$  with *bounded itinerary* lie on hairs. Since our result applies equally well to points with unbounded itinerary, we extend this result to the unbounded case in Section 5. Finally, in Section 6, we prove accessibility.

**2. Basins of Attraction.** In this section we will describe some general properties of the complement of the Julia by summarizing some of the results in [6]. We assume that  $E_\lambda$  has an attracting periodic cycle  $z_0, \dots, z_n = z_0$  of prime period  $n$ , with  $E_\lambda(z_i) = z_{i+1}$ . Throughout we assume that  $n \geq 2$ . Let  $A^*(z_i)$  denote the immediate basin of attraction containing  $z_i$ .

**Definition 2.1.** *An unbounded, simply connected set  $F \subset \mathbb{C}$  is called a finger of width  $c$  if*

- i):  $F$  is bounded by a simple curve  $\gamma \subset \mathbb{C}$ .
- ii): There exists a  $\nu > 0$  such that  $F \cap \{z \mid \operatorname{Re} z > \nu\}$  is simply connected, extends to infinity, and satisfies

$$F \cap \{z \mid \operatorname{Re} z > \nu\} \subset \left\{ z \mid \operatorname{Im} z \in \left[ \xi - \frac{c}{2}, \xi + \frac{c}{2} \right] \right\}$$

for some  $\xi \in \mathbb{R}$ .

With this definition we can now characterize parts of the stable set as shown in [6].

**Theorem 2.1.** *Suppose  $z_0, \dots, z_{n-1}$  is an attracting periodic orbit for  $E_\lambda$  with  $n \geq 2$ . Suppose  $0 \in A^*(z_1)$ . Then there exist disjoint, open, simply connected sets  $C_0, \dots, C_{n-1}$  such that*

- i):  $z_j \in C_j$ ,  $C_j \subset A^*(z_j)$ .
- ii):  $E_\lambda(C_0) = C_1 - \{0\}$ .
- iii):  $E_\lambda(C_j) = C_{j+1}$ ,  $j = 1, \dots, n-2$  and  $E_\lambda(C_{n-1}) \subset C_0$ .
- iv):  $C_1, \dots, C_{n-1}$  are fingers of width  $c_j \leq 2\pi$ .
- v): The complement of  $C_0$  consists of infinitely many disjoint fingers of width  $2\pi$ .

Since this collection of sets will become important later we formulate the following

**Definition 2.2.** *A collection of open subsets  $C_0, \dots, C_{n-1}$  satisfying the conditions in Theorem 2.1 is called a fundamental set of attracting domains for the cycle  $z_0, \dots, z_{n-1}$ . The fingers  $C_1, \dots, C_{n-1}$  are called stable fingers. The region  $C_0$  is called a glove.*

A typical example of a fundamental set of attracting domains for an exponential with an attracting cycle of period 5 is shown in Figure 4. We remark that this figure is actually a caricature, since, for an actual exponential, the width of the fingers  $C_1, C_2$ , and  $C_3$  is small compared to the width of  $C_4$ .

In fact there are many ways to construct a fundamental set of attracting domains. In order to simplify later computations we wish to make the boundaries of the fingers smooth and nearly horizontal in the far right half-plane as those shown in the picture.

**Definition 2.3.** *A smooth curve  $\gamma(t)$  is called horizontally asymptotic to  $c$  if*

- i):  $\lim_{t \rightarrow \infty} \operatorname{Re}(\gamma(t)) = +\infty$ .

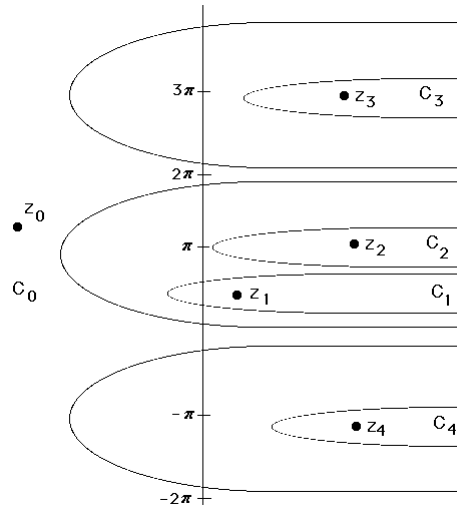

FIGURE 4. A fundamental set of attracting domains.

- ii):  $\lim_{t \rightarrow \infty} \text{Im}(\gamma(t)) = c$ .
- iii):  $\lim_{t \rightarrow \infty} \arg(\gamma'(t)) = 0$ .

The proof of the following can be found in [6].

**Proposition 2.2.** *For a cycle  $z_0, \dots, z_{n-1}$  there exists a fundamental set of attracting domains with the following properties: There are integers  $k_j$  and a parameterization  $\gamma_j(t)$  of the boundary of  $C_j$  which is horizontally asymptotic to*

- i):  $2\pi k_j - \arg(\lambda)$  if  $j = 1, \dots, n-2$
- ii):  $2\pi k_{n-1} - \arg(\lambda) \pm \frac{\pi}{2}$  if  $j = n-1$

where  $k_j \in \mathbb{Z}$  and each of the  $\gamma_j$  have either monotonically increasing or decreasing imaginary parts in the far right half plane. For the glove  $C_0$ , each of the boundary curves is horizontally asymptotic to  $2\pi k - \arg(\lambda)$  for some integer  $k$ .

For the remainder of this paper, we always assume that the fundamental set of attracting domains is chosen to satisfy the above constraints.

**3. Itineraries and the Kneading Sequence.** In this section we review the definition and properties of the *kneading sequence* associated to an exponential with an attracting cycle [6]. This sequence will provide a symbolic way of describing the set of accessible points in  $J(E_\lambda)$ .

By v) in Theorem 2.1, the complement of  $C_0$  consists of infinitely many closed fingers, unbounded in the right half-plane. We denote these fingers by  $\mathcal{H}_k$  where  $k \in \mathbb{Z}$ . We index  $\mathcal{H}_k$  so that  $0 \in \mathcal{H}_0$  and  $k$  increases with increasing imaginary parts. Note that  $J(E_\lambda)$  is contained in the union of the  $\mathcal{H}_k$ .

We have  $E_\lambda(C_0) = C_1 - \{0\}$ , so it follows that  $E_\lambda(\mathcal{H}_k) = \mathbb{C} - C_1$  for each  $k$ . We define  $L_{\lambda,k}$  to be the inverse of  $E_\lambda$  on  $\mathbb{C} - C_1$  which takes values in  $\mathcal{H}_k$ .

Let  $\Sigma = \{(s) = (s_0 s_1 s_2 \dots) \mid s_j \in \mathbb{Z} \text{ for each } j\}$ .  $\Sigma$  is called the *sequence space*. The *shift map*  $\sigma$  on  $\Sigma$  is given by

$$\sigma(s_0 s_1 s_2 \dots) = (s_1 s_2 s_3 \dots).$$

We define the *itinerary*  $S(z)$  of  $z \in J(E_\lambda)$  by

$$S(z) = (s_0 s_1 s_2 \dots) \text{ where } s_j = k \text{ iff } E_\lambda^j(z) \in \mathcal{H}_k.$$

Note that  $S(E_\lambda(z)) = \sigma(S(z))$ . We do not define the itinerary of points outside  $J(E_\lambda)$ .

It is known that there are itineraries that do not correspond to any point in  $J(E_\lambda)$  [14]. For example, there are no points in  $J(E_\lambda)$  that have itineraries of the form  $(s_0 s_1 s_2 \dots)$  when  $|s_j|$  grows faster than an iterated (real) exponential. We let  $\Sigma_a$  denote the set of allowable sequences in the sense that  $(s_0 s_1 s_2 \dots) \in \Sigma_a$  if and only if there exists  $z \in J(E_\lambda)$  whose itinerary is  $(s_0 s_1 s_2 \dots)$ . It can be shown that  $\Sigma_a$  is independent of  $\lambda$  [15].

For each  $C_j$  with  $1 \leq j \leq n-1$ , there exists  $\mathcal{H}_k$  such that  $C_j \subset \mathcal{H}_k$ . We define the kneading sequence for  $\lambda$  as follows.

**Definition 3.1.** *Let  $E_\lambda$  have an attracting cycle of period  $n \geq 2$ . The kneading sequence associated to  $E_\lambda$  is the string of  $n-1$  integers followed by  $*$*

$$K(\lambda) = 0k_1k_2 \dots k_{n-2}*$$

where  $k_i = j$  iff  $E_\lambda^i(0) \in \mathcal{H}_j$ .

Note that the kneading sequence gives the location of  $E_\lambda(0), \dots, E_\lambda^{n-2}(0)$  in terms of the  $\mathcal{H}_k$ . For completeness we also include the location of 0 in  $\mathcal{H}_0$ . Similarly,  $E_\lambda^{n-1}(0)$  lies in  $C_0$ , which is the complement of the  $\mathcal{H}_k$ , and so this will be denoted by  $*$ . We think of  $*$  as a “wild card.” The importance of including this entry will become clear later. Equivalently, the kneading sequence indicates which  $\mathcal{H}_k$  contains the points  $z_1, z_2, \dots, z_{n-1}$  on the orbit of the cycle.

For a sufficiently large real number  $\tau$

$$\Lambda_\tau = \{z \in \mathbb{C} \mid \operatorname{Re} z \geq \tau\} - \bigcup_{j=0}^{n-1} C_j$$

consists of infinitely many closed fingers. Each finger in  $\Lambda_\tau$  is included in precisely one  $\mathcal{H}_j$ .

If  $j$  is not one of the entries in the kneading sequence, then there is only one finger in  $\Lambda_\tau$  that lies in  $\mathcal{H}_j$  (namely the far right portion of  $\mathcal{H}_j$  itself). We denote this finger in  $\Lambda_\tau$  by  $H_j$ .

However, for  $j$  in the kneading sequence, we know that one of the points on the attracting cycle, say  $z_i$ , lies in  $\mathcal{H}_j$ . Thus  $C_i$  separates  $\Lambda_\tau \cap \mathcal{H}_j$  into at least two fingers. Since  $\Lambda_\tau$  has more than one component in  $\mathcal{H}_j$ , we need a way to unambiguously identify them. Assume that  $\Lambda_\tau$  has  $k$  components in  $\mathcal{H}_j$ . In this case, the fingers that lie in  $\mathcal{H}_j$  will be denoted  $H_{j_1}, \dots, H_{j_k}$  where the  $j_\alpha$ 's are ordered with ascending imaginary part. Note that all of these fingers lie in the half plane  $\operatorname{Re} z \geq \tau$ .

Hence we can describe the itinerary of certain points in the Julia set even more precisely by defining an *augmented itinerary* for  $z \in J(E_\lambda) \cap \{z \in \mathbb{C} \mid \operatorname{Re} z \geq \tau\}$ . In an augmented itinerary, we specify which of the  $H_{j_k}$  the orbit of  $z$  visits. More precisely, let  $\mathbb{Z}'$  denote the set whose elements are either integers not contained in the kneading sequence, or subscripted integers  $j_k$  corresponding to an  $H_{j_k}$  if  $j$  is an entry in the kneading sequence. The *augmented itinerary* of  $z$  is

$$S'(z) = (s_0 s_1 s_2 \dots)$$

where each  $s_j \in \mathbb{Z}'$  and  $s_j$  specifies the finger in  $\Lambda_\tau$  containing  $E_\lambda(z)$ .

Let  $\Sigma'$  denote the set of allowable (in the above sense) augmented itineraries. We topologize  $\Sigma'$  in the usual way, so that nearby sequences share the same initial blocks. At this stage, the augmented itinerary is defined only for points whose orbits remain for all time in  $\Lambda_\tau$ , but we will remove this restriction below.

Note that there are further restrictions on which augmented itineraries are allowable. Unlike the case of  $\mathcal{H}_j$ , whose image under  $E_\lambda$  meets all of the other  $\mathcal{H}_k$ , the image of  $H_{j_k}$  under  $E_\lambda$  never meets all of the other fingers.

**Definition 3.2.** *The deaugmentation map is a map  $\mathcal{D} : \Sigma' \rightarrow \Sigma_a$  such that if  $s_n = j_k$  then  $\mathcal{D}(s_n) = j$ . If  $s_n = j$ , then  $\mathcal{D}(s_n) = j$ .*

That is,  $\mathcal{D}$  simply removes the subscript from each subscripted entry in a sequence in  $\Sigma'$ , and leaves other entries alone.

**4. Cantor Bouquets.** Before describing the structure of  $J(E_\lambda)$ , we recall the notion of a *Cantor bouquet*. A Cantor bouquet is a subset of the plane homeomorphic to a *straight brush*, an object we will describe next. This concept is due to Aarts and Oversteegen [1].

To each allowable sequence in  $\Sigma_a$ , we may associate an irrational number in a continuous fashion so that the set  $\mathcal{N}$  of irrationals corresponding to sequences in  $\Sigma_a$  is a dense subset of  $\mathbb{R}$ . There are many ways to do this; see [10] for one specific construction using the Farey tree.

**Definition 4.1.** *A straight brush  $B$  is a subset of  $[0, \infty) \times \mathcal{N}$ , where  $\mathcal{N}$  is a dense subset of the irrationals.  $B$  has the following properties.*

- i):  $B$  is “hairy” in the following sense. If  $(y, \alpha) \in B$ , then there exists a  $y_\alpha \leq y$  such that  $(t, \alpha) \in B$  iff  $t \geq y_\alpha$ . That is all points  $[t, \alpha]$  with  $t \geq y_\alpha$  constitute a “hair” in  $B$ . The point  $(y_\alpha, \alpha)$  is called the endpoint of the hair corresponding to  $\alpha$ .
- ii): Given an endpoint  $(y_\alpha, \alpha) \in B$  there are sequences  $\beta_n \uparrow \alpha$  and  $\gamma_n \downarrow \alpha$  in  $\mathcal{N}$  such that  $(y_{\beta_n}, \beta_n) \rightarrow (y_\alpha, \alpha)$  and  $(y_{\gamma_n}, \gamma_n) \rightarrow (y_\alpha, \alpha)$ . That is, any endpoint of a hair in  $B$  is the limit of endpoints of other hairs from both above and below.
- iii):  $B$  is a closed subset of  $\mathbb{R}^2$ .

The following facts are easily verified (see [1]):

1. For any rational number  $v$  and any sequence of irrationals  $\alpha_n \in \mathcal{N}$  with  $\alpha_n \rightarrow v$ , it can be shown that the hairs  $[y_{\alpha_n}, \alpha_n]$  must tend to  $(\infty, v)$  in  $[0, \infty) \times \mathbb{R}$ .
2. Condition 2 above is equivalent to: if  $(y, \alpha)$  is any point in  $B$  ( $y$  need not be the endpoint of the hair associated to  $\alpha$ ), then there are sequences  $\beta_n \uparrow \alpha$ ,  $\gamma_n \downarrow \alpha$  so that  $(y_{\beta_n}, \beta_n) \rightarrow (y, \alpha)$  and  $(y_{\gamma_n}, \gamma_n) \rightarrow (y, \alpha)$  in  $B$ .
3. Let  $(y, \alpha) \in B$  and suppose  $y \neq y_\alpha$ . Then  $(y, \alpha)$  is inaccessible in  $\mathbb{R}^2$  in the sense that there is no continuous curve  $\gamma : [0, 1] \rightarrow \mathbb{R}^2$  such that  $\gamma(t) \notin B$  for  $0 \leq t < 1$  and  $\gamma(1) = (y, \alpha)$ .
4. On the other hand, all endpoints  $(y_\alpha, \alpha)$  are accessible in  $\mathbb{R}^2$ .

These facts show that a straight brush is a remarkable object from the topological point of view. We consider a straight brush as a subset of the Riemann sphere and set  $B^* = B \cup \infty$ , i.e., the straight brush with the point at infinity added. Let  $\mathcal{E}$

denote the set of endpoints of  $B$ , and let  $\mathcal{E}^* = \mathcal{E} \cup \infty$ . Then we have the following result, due to Mayer [23]:

**Theorem 4.1.** *The set  $\mathcal{E}^*$  is a connected set, but  $\mathcal{E}$  is totally disconnected.*

That is, if we remove just one point from the connected set  $\mathcal{E}^*$ , the resulting set is totally disconnected.

The reason for this is that, if we draw the straight line in the plane  $(\gamma, t)$  where  $\gamma$  is a fixed rational, and then we adjoin the point at infinity, we find a disconnection of  $\mathcal{E}$ . This, however, is not a disconnection of  $\mathcal{E}^*$ . Moreover, the fact that any non-endpoint in  $B$  is inaccessible shows that we cannot disconnect  $\mathcal{E}^*$  by any other curve.

**Remark.** Aarts and Oversteegen have shown that any two straight brushes are ambiently homeomorphic, i.e., there is a homeomorphism of  $\mathbb{R}^2$  taking one brush onto the other. This leads to a formal definition of a Cantor bouquet.

**Definition 4.2.** *A Cantor bouquet is a subset of  $\mathbb{C}^*$  that is homeomorphic to a straight brush (with  $\infty$  mapped to  $\infty$ ).*

The connection with exponential dynamics arises from the following result proved in [1].

**Theorem 4.2.** *Suppose  $0 < \lambda < 1/e$ . Then  $J(E_\lambda)$  is a Cantor bouquet.*

In this case, the dense subset  $\mathcal{N}$  of the irrationals is identified in a natural way with the set of allowable itineraries  $\Sigma_a$ .

In the above theorem,  $E_\lambda$  has an attracting fixed point. Our goal below is to prove an analogous result in the attracting cycle case. In this analogy, we will think of a Cantor bouquet as being a subset of  $[0, \infty) \times \Sigma'$  rather than  $[0, \infty) \times \Sigma_a$ . This will yield a modified straight brush.

**5. The Modified Brush.** In the case of an attracting cycle of period two or more,  $J(E_\lambda)$  is no longer a Cantor bouquet. It is true that all points in  $J(E_\lambda)$  lie on hairs, but some of these hairs share the same endpoint [6]. In this section we will show that there is a unique hair in the Julia set corresponding to any allowable augmented sequence in  $\Sigma'$ . Moreover, any two hairs corresponding to sequences with the same deaugmentation share an endpoint. We therefore modify the straight brush construction to take into account this pinching.

For a specified  $p_\lambda \in \mathbb{R}$ , we will first introduce in this section a preliminary brush

$$\mathcal{MB}' \subset [p_\lambda, \infty) \times \Sigma'.$$

The modified straight brush  $\mathcal{MB}$  will then be the quotient  $\mathcal{MB}' / \sim$  via an equivalence relation defined below. Finally, we prove the existence of a homeomorphism

$$\phi: \mathcal{MB} \rightarrow J(E_\lambda).$$

The construction of  $\mathcal{MB}'$  and  $\phi$  will be similar in spirit to that in [1], hence we will only specify the necessary modifications of the Aarts-Oversteegen construction.

We first define three quantities

$$p_\lambda, r_\lambda, q_\lambda$$

as follows:



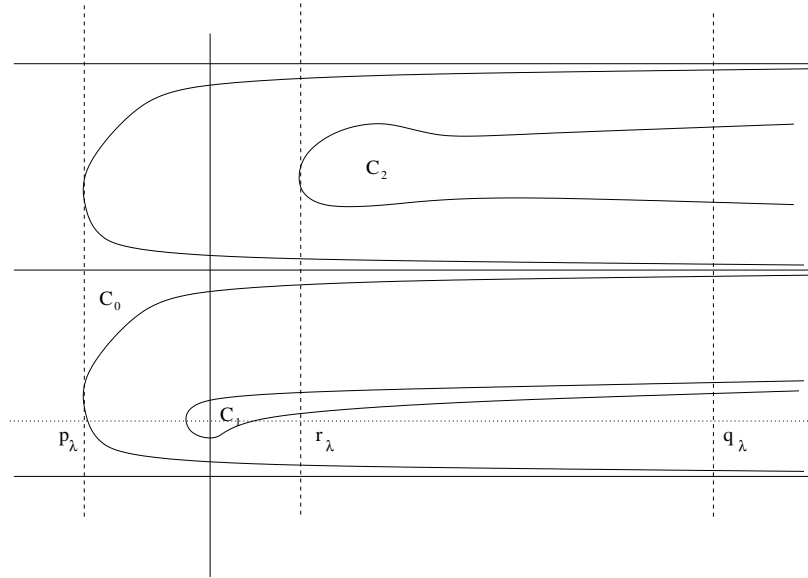

**Definition 5.1.** Let  $p_\lambda \in \mathbb{R}$  such that

$$\{\operatorname{Re} z = p_\lambda\} \cap \mathcal{H}_i \neq \emptyset,$$

but for all  $\alpha < p_\lambda$ ,

$$\{\operatorname{Re} z = \alpha\} \cap \mathcal{H}_i = \emptyset.$$

In other words,  $p_\lambda$  is the real part of the leftmost point(s) in each of the  $\mathcal{H}_i$ .

Let  $q_\lambda$  be such that

- i): to the right of  $q_\lambda$ , the boundaries of the  $\mathcal{H}_k$  are monotonic (increasing imaginary parts on top, decreasing on the bottom).
- ii):  $q_\lambda$  is sufficiently far to the right so that the image of  $\{z | \operatorname{Re}(z) = q_\lambda\}$  under  $E_\lambda$  intersects each  $C_i$  in a single component which is to the right of  $q_\lambda$  and  $\{z | \operatorname{Re}(z) = q_\lambda\} \cap C_i$  has only one nonempty component.
- iii):  $q_\lambda$  is far enough to the right so that  $|\lambda|e^{q_\lambda} > (q_\lambda - p_\lambda)$ .
- iv):  $q_\lambda > -\ln(|\lambda|)$ , i.e., to the right of the line  $x = q_\lambda$ ,  $|E'_\lambda(z)| > 1$  so that  $E_\lambda$  is expanding.

Lastly, we choose the smallest  $r_\lambda \in \mathbb{R}$  such that  $\{z | \operatorname{Re} z = t\} \cap C_i$  is a single, nonempty interval for all  $t \geq r_\lambda$  and all  $i = 1, \dots, n-1$ , i.e., a point to the right of which all fingers are present. See Figure 5.

The existence of  $r_\lambda$  and  $q_\lambda$  is guaranteed by Proposition 2.2. The reasons for these choices will be clear from the construction that follows.

For any itinerary  $\mathbf{s} = (s_0 s_1 s_2 \dots) \in \Sigma'$ , we will define the family of “boxes”  $S(x, s_i)$ , one in each finger  $\mathcal{H}_{\mathcal{D}(s_i)}$ , where  $\mathcal{D}(s_i)$  is the deaugmentation of  $s_i$ . We first define preliminary boxes  $D(x, s_i)$ .

**Definition 5.2.** Let  $L = q_\lambda - p_\lambda$ . For each  $x \in [p_\lambda, \infty)$  and  $s_i = n_k$  or  $n$ , let

$$D(x, s_i) = \mathcal{H}_{\mathcal{D}(s_i)} \cap \{z | x \leq \operatorname{Re} z \leq x + L\} - \bigcup_{i=1}^{n-1} C_i,$$

where  $\mathcal{D}(s_i)$  is the deaugmentation of  $s_i$ .

Roughly,  $D(x, s_i)$  is a “rectangle” in  $\mathcal{H}_{\mathcal{D}(s_i)}$ , with width  $L$ , with “horizontal” pieces cut out by the fingers  $C_i$ . For the definition of the  $S(x, s_i)$ , there are two cases:

**Definition 5.3.** i) If  $s_i = n$  (not augmented), then we set

$$S(x, s_i) = D(x, s_i).$$

ii) If  $s_i = n_k$  (augmented), then we set

- (a) For  $x \geq r_\lambda$  we set  $S(x, s_i)$  to be the  $k$ th component of  $D(x, s_i)$  (counted with ascending imaginary part).
- (b) For  $x < r_\lambda$  let  $S(x, s_i)$  be the component of  $D(x, s_i)$  whose right hand edge lies in  $H_{n_k}$ .

Now we turn to the construction of the preliminary brush  $\mathcal{MB}'$  in  $[p_\lambda, \infty) \times \Sigma'$ . First, for any  $x \in [p_\lambda, \infty)$  and  $\mathbf{s} \in \Sigma'$ , define a sequence of real numbers  $\{x_0, x_1, \dots\}$  and a sequence of boxes  $R(x_i, s_i)$  inductively:

**Definition 5.4.** Let  $x_0 = x$  and  $R(x_0, s_0) = S(x, s_0)$ . Suppose that  $x_l$  and  $R(x_l, s_l)$  have been defined for  $l \leq k$ . Then there are two cases:

i)  $R(x_k, s_k) \neq \emptyset$  and there is a  $\xi$  such that

$$S(\xi, s_{k+1}) \subset E_\lambda(R(x_k, s_k)).$$

Define  $\xi_{\min}$  to be the minimum  $\xi$  that satisfies the above and set

$$x_{k+1} = \xi_{\min}, \quad R(x_{k+1}, s_{k+1}) = S(\xi_{\min}, s_{k+1}).$$

ii) If  $R(x_k, s_k) = \emptyset$  or if there is no  $\xi$  as above, then set

$$x_{k+1} = x_k, \quad R(x_{k+1}, s_{k+1}) = \emptyset.$$

If  $R(x_k, s_k) = \emptyset$  for some  $k$ , we say that the sequence of boxes terminates. If the sequence of boxes does not terminate, then

$$E_\lambda(R(x_k, s_k)) \supset R(x_{k+1}, s_{k+1})$$

for each  $k$ .

**Definition 5.5.** The preliminary brush  $\mathcal{MB}'$  is the set of points  $(x, \mathbf{s})$  for which the sequence of boxes  $R(x_k, s_k)$  does not terminate, i.e.,

$$\mathcal{MB}' = \{(x, \mathbf{s}) \in [p_\lambda, \infty) \times \Sigma' \mid R(x_k, s_k) \neq \emptyset\}$$

Following Aarts and Oversteegen [1], we will show that for  $(x, \mathbf{s}) \in \mathcal{MB}'$ , there is a unique point whose orbit visits the  $R(x_k, s_k)$  sequentially for all  $k$ . Unlike the case in [1], however, two different sequences of boxes may yield the same point. To remedy this, we identify points  $(x, \mathbf{s}), (y, \mathbf{s}) \in \mathcal{MB}'$  for which

$$R(x_k, s_k) \cap R(y_k, s_k) \neq \emptyset,$$

for all  $k$ . In such cases we will write  $(x, \mathbf{s}) \sim (y, \mathbf{s})$ . We will see below that, whenever two such points are identified, these points always correspond to an endpoint of a hair. First we note:

**Proposition 5.1.** The relation  $\sim$  is an equivalence relation.

**Proof:**

The symmetry and reflexivity of  $\sim$  follow directly from its definition. To prove transitivity assume that  $R(x_k, s_k) \cap R(y_k, s_k) \neq \emptyset$  and  $R(y_k, s_k) \cap R(z_k, s_k) \neq \emptyset$ , and that there exists a  $K \geq 0$  such that  $R(x_K, s_K) \cap R(z_K, s_K) = \emptyset$ . By part iv) of Definition 5.1 the box  $R(z_K, s_K)$  must be in the region where  $E_\lambda$  is expanding. It follows that  $y_k - z_k \rightarrow \infty$  as  $k \rightarrow \infty$  which is a contradiction.  $\square$

**Proposition 5.2.** *Fix an itinerary  $\mathbf{s}$ . Let  $x$  be such that the box construction does not terminate, then the set*

$$\{y \mid (x, \mathbf{s}) \sim (y, \mathbf{s})\},$$

*i.e., the equivalence class containing  $x$ , is a closed interval.*

**Proof:**

For a fixed itinerary  $\mathbf{s}$  the dependence of  $x_{k+n}$  for  $n > 1$  on  $x_k$  is monotone, i.e., if  $x_k < y_k$  then  $x_{k+1} < y_{k+1}$ . Let  $(x, \mathbf{s}) \sim (y, \mathbf{s})$  and  $(\xi, \mathbf{s})$  be such that  $x < \xi < y$ . We know that  $x_k < \xi_k < y_k$  for all  $k$  and hence  $(x, \mathbf{s}) \sim (\xi, \mathbf{s}) \sim (y, \mathbf{s})$ . Therefore this set is an interval.

We will show that, for a given itinerary  $\mathbf{s}$  and fixed  $x$ , the set

$$\{y \mid (x, \mathbf{s}) \not\sim (y, \mathbf{s})\}$$

is open. There are two possibilities:

- i) If the sequence  $R(y_k, s_k)$  does not terminate then there is some  $K$  for which

$$R(x_K, s_K) \cap R(y_K, s_K) = \emptyset.$$

Since these two sets are closed, there is some  $\epsilon$  such that

$$d(R(x_K, s_K), R(y_K, s_K)) > \epsilon.$$

It follows that there is an open neighborhood  $N$  around  $y_K$ , such that for all  $y'_K \in N$ ,

$$R(x_K, s_K) \cap R(y'_K, s_K) = \emptyset.$$

Since  $E_\lambda$  is continuous, there is an open neighborhood  $N_0$  around  $y_0 = y$ , such that for any  $y'_0 \in N_0$  the corresponding point  $y'_K$  is in  $N$ . Therefore  $(y', \mathbf{s}) \not\sim (x, \mathbf{s})$  for all points in an open neighborhood of  $x$ .

- ii) Suppose that the sequence of boxes  $R(y_k, s_k)$  terminates. The construction terminates at the  $K$ -th step if the circle  $|z| = |\lambda|e^{y_K}$  does not contain the set  $\{z \mid z \in \mathcal{H}_{K+1} \text{ and } \operatorname{Re} z < q_\lambda\}$  in its interior. The set of  $y_K$  which satisfy this condition is open, and since  $E_\lambda^K$  is a continuous map, this is an open condition on  $y_0 = y$ . Therefore for a fixed itinerary  $\mathbf{s}$ , the set

$$I_{\mathbf{s}, K} = \{y \mid \text{the sequence of boxes } R(y_K, s_K) \text{ terminates}\}$$

is open. The set of all  $y$  for which the sequence terminates is

$$I_{\mathbf{s}} = \bigcup_K I_{\mathbf{s}, K}$$

which is also open.

□

For any itinerary  $\mathbf{s}$  for which there exists an  $x$  with  $(x, \mathbf{s}) \in \mathcal{MB}'$ , let  $x_{\mathbf{s}}^{\min}$  be the smallest such number. By considering the set

$$A_{\mathbf{s}} = \{y \mid (x_{\mathbf{s}}^{\min}, \mathbf{s}) \sim (y, \mathbf{s})\}$$

we define

$$\bar{x}_{\mathbf{s}} = \sup A_{\mathbf{s}}.$$

We now show that the only equivalence class that possibly consists of more than one point is the equivalence class containing  $(\bar{x}_{\mathbf{s}}, \mathbf{s})$ .

**Proposition 5.3.** *For any  $(x, \mathbf{s}), (y, \mathbf{s}) \in \mathcal{MB}'$  with  $\bar{x}_{\mathbf{s}} \leq x < y$  there is a  $K$  so that for all  $k \geq K$ ,*

$$R(x_k, s_k) \cap R(y_k, s_k) = \emptyset.$$

**Proof:** Assume for contradiction that  $R(x_k, s_k) \cap R(y_k, s_k) \neq \emptyset$  for all  $k$ . Then there are two cases:

1. We can have

$$R(x_k, s_k) \cap R(y_k, s_k) \cap R(\bar{x}_{\mathbf{s}, k}, s_k) \neq \emptyset$$

for all  $k$ . But recall that  $\bar{x}_{\mathbf{s}}$  was defined to be the largest real number with the property that it was equivalent to  $x_{\mathbf{s}}^{\min}$ . This would imply that both  $x, y \leq \bar{x}_{\mathbf{s}}$ , which is a contradiction.

2. We can have

$$R(x_k, s_k) \cap R(y_k, s_k) \cap R(\bar{x}_{\mathbf{s}, k}, s_k) = \emptyset$$

for some  $k$ . Assume for specificity that  $x < y$ . Then  $y_k$  is to the right of the box containing  $\bar{x}_{\mathbf{s}, k}$  by our assumptions, and hence lies to the right of the line  $\{z \mid \operatorname{Re} z = q_{\lambda}\}$ . Therefore the subsequent  $y_i$  in the construction will move away from the  $x_i$  like an iterated exponential, and thus their corresponding boxes will stop intersecting, which yields a contradiction.

□

We may finally define the modified straight brush.

**Definition 5.6.** *The modified straight brush  $\mathcal{MB}$  is the quotient  $\mathcal{MB}' / \sim$  endowed with the quotient topology. Also define the map*

$$\phi : \mathcal{MB} \longrightarrow J(E_{\lambda})$$

as follows. For each  $(x, \mathbf{s}) \in \mathcal{MB}, k \in \mathbb{N}$  let

$$B_k(x, \mathbf{s}) = \{z \in \mathbb{C} \mid E_{\lambda}^i(z) \in R(x_i, s_i) \text{ for } 0 \leq i \leq k\}$$

and set

$$\phi(x, \mathbf{s}) = \bigcap_{k=0}^{\infty} B_k(x, \mathbf{s}).$$

As in [1], each  $B_k$  is a well-defined set which is compact and simply connected. Also,  $B_{k+1}(x, \mathbf{s}) \subset B_k(x, \mathbf{s})$ , so that  $\phi(x, \mathbf{s})$  is a nested intersection of compact sets.

**Proposition 5.4.** *For all  $(x, \mathbf{s}) \in \mathcal{MB}$  the set  $\bigcap_{k=0}^{\infty} B_k(x, \mathbf{s})$  consists of a single point.*

**Proof:** The map  $E_\lambda$  is expanding on its Julia set, i.e.,  $|(E_\lambda^n)'(z)| \rightarrow \infty$  as  $n \rightarrow \infty$  for any  $z \in J(E_\lambda)$ . See [24]. Since we have a nested intersection of compact sets, it follows that

$$\gamma = \bigcap_{k=0}^{\infty} B_k(x, \mathbf{s})$$

must be a continuum, i.e., a closed connected set. We claim that  $\gamma$  consists of a single point. To show this, assume that  $\gamma$  contains more than one point in  $R(x_0, s_0)$ . Now  $\gamma \subset J(E_\lambda)$  since the orbits of points in  $\gamma$  do not tend to the attracting cycle.

Pick any point  $z \in \gamma$ . Since  $\gamma$  is a continuum there exists sufficiently small disk  $D(z, \varepsilon)$  around  $z$  such that the boundary  $\partial D(z, \varepsilon)$  intersects  $\gamma$ . Let  $w$  be a point in this intersection. Using expansiveness, we find an  $n$  such that

$$|(E_\lambda^n)'(z)| > \frac{144}{\varepsilon} \cdot \sqrt{L^2 + (2\pi)^2}$$

where  $L = q_\lambda - p_\lambda$  is the width of any  $R(x_n, s_n)$ . Since  $E_\lambda^n$  is an analytic function on  $D(z, \varepsilon)$ , it follows from Bloch's Theorem that  $E_\lambda^n(D(z, \varepsilon))$  contains a disk of radius

$$\frac{1}{72} \varepsilon |(E_\lambda^n)'(z)|.$$

Since  $|z - w| = \varepsilon$  it follows that

$$|E_\lambda^n(z) - E_\lambda^n(w)| > 2\sqrt{L^2 + (2\pi)^2}$$

and since  $z \in R(x_n, s_n)$  and each  $R(x_n, s_n)$  is contained in a rectangle of height  $2\pi$  and width  $L$ , the image of  $w$  must lie outside of  $R(x_n, s_n)$  which contradicts our assumption.

□

Hence we have shown that the map  $\phi(x, \mathbf{s})$  is well defined, however, it is not quite a homeomorphism. Each line  $[\bar{x}_s, \infty) \times \mathbf{s} \subset \mathcal{MB}$  maps to a hair in  $J(E_\lambda)$  with endpoint  $\phi(x_s, \mathbf{s})$ . By the results in [6] we know that hairs whose itineraries have the same deaugmentation share the same endpoint. Hence we will consider the brush  $\mathcal{MB}$  without endpoints. Define

$$\widetilde{\mathcal{MB}} = \mathcal{MB} - \{(\bar{x}_s, \mathbf{s}) \mid \mathbf{s} \in \Sigma'\}.$$

**Proposition 5.5.** *The map  $\phi: \widetilde{\mathcal{MB}} \rightarrow J(E_\lambda)$  is injective. The map  $\phi: \mathcal{MB} \rightarrow J(E_\lambda)$  is continuous.*

**Proof:** Let  $(x, \mathbf{s}), (y, \mathbf{s}') \in \mathcal{MB}$  with  $(x, \mathbf{s}) \neq (y, \mathbf{s}')$ . We only need to show that

$$R(x_k, \mathbf{s}_k) \cap R(y_k, \mathbf{s}'_k) = \emptyset \tag{1}$$

for some  $k$ , since this implies  $B_k(x, \mathbf{s}) \cap B_k(y, \mathbf{s}') = \emptyset$ .

Suppose first that  $\mathbf{s} = \mathbf{s}'$ . Thus  $x \neq y$ . We can assume without loss of generality that  $x > y > \bar{x}_s$ . By the definition of  $x_s$ , and the argument used above in Proposition 5.3 there exist constants  $K_x, K_y$  such that

$$R(\bar{x}_{s,k}, s_k) \cap R(x_k, s_k) = \emptyset \text{ for all } k \geq K_x,$$

$$R(\bar{y}_{s',k}, s'_k) \cap R(y_k, s'_k) = \emptyset \text{ for all } k \geq K_y.$$

Let  $K = \max(K_x, K_y)$ . Then  $x_k, y_k > q_\lambda$  for all  $k > K$  so that  $x_k$  and  $y_k$  are in the region where  $E_\lambda$  is expanding (see Definition 5.1). By monotonicity

$$y_k - x_k \rightarrow \infty, \quad \text{as } k \rightarrow \infty.$$

and therefore condition (1) is satisfied for a sufficiently large  $k$ .

On the other hand, if  $\mathbf{s} \neq \mathbf{s}'$  the two sequences must differ in some entry  $k$ , i.e.,  $s_k \neq s'_k$ . We would like to conclude that the corresponding boxes then lie in different strips and hence are disjoint. If the deaugmentations of these entries are different, i.e. if  $\mathcal{D}(s_k) \neq \mathcal{D}(s'_k)$ , then we are done, since the boxes  $R(x_k, \mathbf{s}_k)$  and  $R(y_k, \mathbf{s}'_k)$  do lie in different strips, and therefore they do not intersect.

So assume that  $\mathcal{D}(s_k) = \mathcal{D}(s'_k)$ . Recalling the construction of the  $S(x, s_i)$ , if  $x_k \leq q_\lambda$ , and  $s_k \neq s'_k$ , but  $\mathcal{D}(s_k) = \mathcal{D}(s'_k)$ , then  $R(x_k, s_k) = R(x_k, s'_k)$ , and so of course it is possible that  $R(x_k, s_k) \cap R(y_k, s'_k) \neq \emptyset$ . It was shown in [6] that if two sequences have the same deaugmentation, and the augmented sequences differ at the  $k$ th step (i.e.  $\mathcal{D}(\mathbf{s}) = \mathcal{D}(\mathbf{s}')$  but  $s_k \neq s'_k$ ), then  $s_l \neq s'_l$  for all  $l \geq k$ . Since  $x > \bar{x}_\mathbf{s}$ , we know that there is a  $m$  such that  $x_m > q_\lambda$ . From this and [6] we can find an  $m$  such that  $x_m > q_\lambda$  and  $s_m \neq s'_m$ , and thus  $R(x_k, s_k) \cap R(y_k, s'_k) = \emptyset$ .

Next we will show that the map  $\phi(x, \mathbf{s})$  is continuous. Fix  $(x, \mathbf{s}) \in \mathcal{MB}$ . We want to show that if  $(x', \mathbf{s}')$  is close to  $(x, \mathbf{s})$  then  $\phi(x', \mathbf{s}')$  is close to  $\phi(x, \mathbf{s})$ . Fix  $N$ . Choose  $\mathbf{s}' \in \Sigma'$  with  $s_i = s'_i$  for all  $i \leq N$ . Since  $E_\lambda$  is continuous, we can choose  $x'$  close to  $x$  so that

$$R(x_i, s_i) \cap R(x'_i, s'_i) \neq \emptyset \text{ for all } i \leq N.$$

Then  $\phi(x', \mathbf{s}')$  is close to  $\phi(x, \mathbf{s})$  since  $E_\lambda$  is expanding.

□

Now we need only surjectivity:

**Proposition 5.6.** *For any  $z \in J(E_\lambda)$  there exists  $(x, \mathbf{s}) \in \mathcal{MB}$  such that  $\phi(x, \mathbf{s}) = z$ .*

**Proof:** Let  $\mathbf{s}$  be the itinerary of  $z$ . We will find an  $x$  such that  $E_\lambda^k(z) \in R(x_k, s_k)$  and hence  $\phi(x, \mathbf{s}) = z$ .

For each  $k \in \mathbb{N}$  let  $R_k^k = S(u, s_k)$  with

$$u = \inf\{w \mid w \geq p_\lambda \text{ and } E_\lambda^k(z) \in S(w, s_k)\}.$$

That is,  $R_k^k$  is the box whose right hand edge has real part equal to  $\text{Re } E_\lambda^k(z)$ . The boxes  $R_l^k$  with  $0 \leq l < k$  are defined inductively as follows: If  $R_{l+1}^k$  is defined then let

$$R_l^k = S(\nu, s_l)$$

where  $\nu = \sup\{\mu \mid R_{l+1}^k \subset E_\lambda(S(\mu, s_{k-1}))\}$ .

Let  $t_k \in \mathbb{R}$  be the point such that

$$R_0^k = S(t_k, s_0).$$

By construction  $p_\lambda \leq t_k \leq t_{k+1} \leq \text{Re}(z)$  for all  $k$  so that

$$t_\infty = \lim_{k \rightarrow \infty} t_k$$

exists. It follows from the construction that  $\phi(t_\infty, \mathbf{s}) = z$ . □

This yields the following

**Theorem 5.7.** *If  $E_\lambda$  has an attracting cycle, then there exists a brush  $\mathcal{MB} \subset \mathbb{R} \times \Sigma'$  and a continuous map  $\phi : \mathcal{MB} \rightarrow J(E_\lambda)$  such that  $\phi|_{\overline{\mathcal{MB}}}$  is a homeomorphism.*

**6. Accessibility.** When  $E_\lambda$  admits an attracting fixed point, [12] posed and answered the question: What points of the Julia set are *accessible* from the basin of attraction of the fixed point? There it was shown that the points in the Julia set which are accessible are precisely the set of endpoints of hairs (and  $\infty$ ) and that no other points on the hairs are accessible. The obstruction to accessibility is as follows: Choose a point properly on a hair (i.e. not an endpoint). This point is a limit point of endpoints of other hairs. This “haze” of other hairs around the endpoint prevents a curve from reaching it “from the side” (See [1]). The endpoints are in this case accessible since we can approach them “head on”.

Our goal in this section is to prove a similar result in the case of attracting cycles. The obstruction described above still exists in this case: only endpoints (and  $\infty$ ) are accessible from the attracting cycle. However, there are additional obstructions. In particular, the itineraries which are not accessible are those which have been “pinched out” of the picture, i.e., those that are behind a collection of pinched hairs.

**Definition 6.1.** *Suppose that  $E_\lambda$  has an attracting cycle. Let  $B$  be a component of the basin of attraction of the cycle. A point  $z \in J(E_\lambda)$  is accessible from  $B$  if there exists a continuous curve  $\gamma : [0, \infty) \rightarrow B$  satisfying  $\lim_{t \rightarrow \infty} \gamma(t) = z$ . The point  $z$  is accessible if there exists some component  $B$  of the basin of attraction for which  $z$  is accessible from  $B$ .*

Recall that the kneading sequence associated to  $\lambda$  is a string of the form  $K(\lambda) = 0k_1 \dots k_{n-2}*$  where the  $k_j$  are integers and  $*$  is the “wild card.” Our goal in this section is to prove:

**Theorem 6.1.** *Suppose  $E_\lambda$  has an attracting cycle and kneading sequence  $K(\lambda) = 0k_1 \dots k_{n-2}*$ . Then a point  $z \in J(E_\lambda)$  is accessible iff  $z$  is an endpoint in  $J(E_\lambda)$  whose (deaugmented) itinerary is allowable and of the form*

$$u0kt_10kt_20kt_3 \dots$$

Here  $u = u_1u_2 \dots u_n$  is a finite sequence,  $0k = 0k_1k_2 \dots k_{n-2}$  is  $K(\lambda)$  without the wild card, and  $t_j \in \mathbb{Z}$ .

Note that the integers  $t_j$  that replace the wild card above are completely arbitrary provided that the final sequence is allowable. We remark that any allowable sequence of the  $t_j$  yields an allowable sequence of the above form. The converse, however, is not true.

To make precise and prove the claims above, we will use a box construction similar to that of the previous sections. Recall that

$$D(x, s_i) = \mathcal{H}_{\mathcal{D}_{s_i}} \cap \{z \mid x \leq \operatorname{Re} z \leq x + L\} - \bigcup_{i=1}^{n-1} C_i$$

is a box of length  $L$  in the finger  $\mathcal{H}_{\mathcal{D}_{s_i}}$  which may consist of several components. We also need to add the following condition to Definition 5.1:

**v)** *Choose  $q_\lambda$  sufficiently large so that if  $w_k$  is a leftmost point of the finger  $\mathcal{H}_k$ , i.e.,  $\operatorname{Re}(w_k) = p_\lambda$ , then  $E_\lambda^{n-1}(w_k) \in D(p_\lambda, s_{n-1})$ .*

In other words, we require that the  $(n-1)$ -st iterate of the leftmost point of the fingers is contained in the leftmost box of length  $L$ .

Given an allowable deaugmented itinerary  $\mathbf{s} = s_0 s_1 \dots$ , we define numbers  $x_j^k$  and the boxes  $B_j^k$  as follows:

1. Let  $x_j^0 = p_\lambda$ ,  $B_j^0 = D(p_\lambda, s_j)$  for all  $j$ .
2. Assume that  $B_j^k$  has been defined for all  $l \leq k$  and for all  $j$ .

Then we choose

$$x_j^{k+1} = \sup_x \{E_\lambda(D(x, s_j)) \cap B_{j+1}^k\},$$

and define  $B_j^{k+1} = D(x_j^{k+1}, s_j)$ . In short,  $B_j^{k+1}$  is the rightmost box in  $\mathcal{H}_{s_j}$  whose image covers  $B_{j+1}^k$ .

It is clear from the construction that the sequence  $\{x_j^k\}_{k=0}^\infty$  is monotonically increasing. The following lemma shows that the sequence converges to a point  $x_j^\infty$ , and that the corresponding boxes  $B_j^\infty = D(x_j^\infty, s_j)$  can be used to define the endpoint  $z_\mathbf{s}$  of hairs with deaugmented itinerary  $\mathbf{s}$ .

**Lemma 6.2.** *If  $\mathbf{s}$  is an allowable itinerary then*

$$x_j^\infty = \lim_{k \rightarrow \infty} x_j^k,$$

*exists. Moreover, if we let  $B_j^\infty = D(x_j^\infty, s_j)$  then*

$$z_\mathbf{s} = \{z \in \mathbb{C} \mid E_\lambda^j(z) \in B_j^\infty \text{ for all } j\} \quad (2)$$

*consists of one point and  $z_\mathbf{s} = \phi(\bar{x}_\mathbf{s}, \mathbf{s})$ .*

**Proof:**  $z_\mathbf{s}$  is a point that depends only on the deaugmentation of a sequence  $\mathbf{s}$ . Let the point  $\bar{x}_\mathbf{s}$  be defined as in the previous section so that the sequence of boxes  $D(\bar{x}_{\mathbf{s},j}, s_j)$  have the property that  $E_\lambda^j(z_\mathbf{s}) \in D(\bar{x}_{\mathbf{s},j}, s_j)$  for all  $j \geq 0$ .

Since  $x_j^0 = p_\lambda$ , clearly  $x_j^0 \leq \bar{x}_{\mathbf{s},j}$ . By the construction given in Definition 5.2 it follows that  $x_{j-k}^k \leq \bar{x}_{\mathbf{s},j-k}$  for all  $0 \leq k \leq j$ . Since this argument holds for all  $j$  and since the sequence  $\{x_j^k\}_{k=0}^\infty$  is monotone, it follows that

$$x_j^\infty = \lim_{k \rightarrow \infty} x_j^k \leq \bar{x}_{\mathbf{s},j}$$

Since  $x_0^\infty \leq \bar{x}_\mathbf{s}$  it follows from Proposition 5.2 and the definition of  $\bar{x}_\mathbf{s}$  that  $(\bar{x}_\mathbf{s}, \mathbf{s}) \sim (x_0^\infty, \mathbf{s})$ . As shown in the previous section, this implies that  $\phi(x_0^\infty, \mathbf{s}) = \phi(\bar{x}_\mathbf{s}, \mathbf{s})$ . By definition  $D(x_j^\infty, s_j) \subset B_j^\infty$  which implies equality (2).  $\square$

This Lemma provides another way of finding the endpoint of the hair with itinerary  $\mathbf{s}$ . In contrast to the previous construction, in the present case the endpoint is approached from the right. As a special case of Theorem 6.1, we now prove:

**Theorem 6.3.** *If  $E_\lambda$  has an attracting  $n$ -cycle  $z_0, z_1, \dots, z_{n-1}$  and kneading sequence  $0k_1k_2 \dots k_{n-2}^*$  then, the endpoint  $z_\mathbf{s}$  of hairs with deaugmented itinerary  $\mathbf{s}$  is accessible from  $C_0$  iff  $\mathbf{s}$  is allowable and of the form*

$$\mathbf{s} = t_0 0k_1k_2 \dots k_{n-2} t_1 0k_1k_2 \dots k_{n-2} t_2 \dots$$

*with  $t_i \in \mathbb{Z}$  for all  $i$ .*

**Proof:** Assume that  $\mathbf{s}$  does not have the assumed form, and that there exists a path  $\gamma : [0, \infty) \rightarrow C_0$  such that  $\gamma(0) = z_0$  and  $\lim_{t \rightarrow \infty} \gamma(t) = z_\mathbf{s}$ .



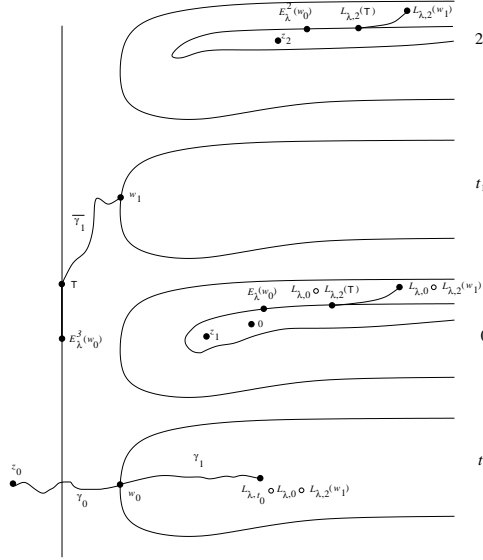

FIGURE 5. The first few steps in the construction with kneading sequence 02\*

Therefore there exist  $j$  and  $0 \leq l \leq n - 2$  such that  $s_{nj+l} \neq k_l$ . This implies that  $E_\lambda^{nj+l}(z_s) \in \mathcal{H}_{s_{nj+l}}$  and  $E_\lambda^{nj+l}(z_0) \in \mathcal{H}_{k_l} \neq \mathcal{H}_{s_{nj+l}}$ , in other words the two iterates are in two different  $\mathcal{H}_j$ . It follows that since  $E_\lambda^{nj+l}(\gamma)$  connects  $E_\lambda^{nj+l}(z_s)$  and  $E_\lambda^{nj+l}(z_0)$  it must intersect  $J(E_\lambda)$ . Since the Julia set is invariant this means that  $\gamma \cap J(E_\lambda) \neq \emptyset$ , and hence cannot be fully contained in the stable set of  $E_\lambda$ . This yields a contradiction.

Next we will assume that  $\mathbf{s}$  is of the form given in the assumption and construct a curve  $\gamma : [0, \infty) \rightarrow \mathbb{C}$  such that  $\gamma(0) = z_0$  and  $\lim_{t \rightarrow \infty} \gamma(t) = z_s$ . This construction is similar to that given in [12].

For  $0 \leq j \leq n - 1$  let the regions  $C_i$  be defined as in Section 2, and let  $C_n = E_\lambda^n(C_0)$ . As shown in Section 2,  $C_n$  is a proper subset of  $C_0$ .

Let  $w_l \in \mathcal{H}_{t_l}$  be a point such that  $\text{Re}(w_l) = p_\lambda$  so that  $w_l$  is the leftmost point of  $\mathcal{H}_{t_l}$ . The curve  $\gamma$  will be defined as a union of preimages of curves  $\bar{\gamma}_l$  constructed as follows:

Let  $\gamma_0 : [0, 1] \rightarrow C_0$  be a curve connecting  $z_0$  and  $w_0$  inside  $C_0$ . Since  $w_{l-1}$  is on the boundary of  $C_0$ ,  $E_\lambda^n(w_{l-1})$  is a point on the boundary of  $C_n$ . Note that  $B_{l_{n-1}}^1$  is the rightmost box in the  $k_{n-2}$  strip which covers  $\mathcal{H}_{t_l}$ . Let  $\bar{\gamma}_l : [l, l+1] \rightarrow \mathbb{C}$  be the curve joining  $E_\lambda^n(w_{l-1})$  along the boundary of  $C_n$  to the inner boundary of the annulus  $E_\lambda(B_{l_{n-1}}^1)$ , and continuing to the point  $w_l$  inside this annulus (see Figure). By definition  $\bar{\gamma}_l$  is a curve inside  $C_0$  such that  $\bar{\gamma}_l(l) = E_\lambda^n(w_{l-1})$  and  $\bar{\gamma}_l(l+1) = w_l$ .

Let  $L_{\lambda,i}$  be the branch of the logarithm defined on the  $i$ -th finger. The path  $\bar{\gamma}_l$  can be pulled back to the strip  $\mathcal{H}_{t_0}$  by applying the appropriate logarithms:

$$\gamma_l = L_{\lambda,t_0} \circ L_{\lambda,0} \circ L_{\lambda,k_1} \circ \cdots \circ L_{\lambda,k_{n-2}}(\bar{\gamma}_l),$$

so that  $E_\lambda^{nl}(\gamma_l) = \bar{\gamma}_l$ . The path  $\gamma : [0, \infty) \rightarrow \mathbb{C}$  can now be defined as the union of all the paths  $\gamma_l$  parameterized in a natural way.

Note that each  $\gamma_l$  is in the stable set of  $E_\lambda$  since  $E_\lambda^{nl}(\gamma_l) \subset C_0$ .

We define

$$T_j^l = \bigcup_{p_\lambda \leq x \leq x_j^l} D(x, t_0),$$

so that  $T_j^l$  is the box  $B_j^l$  and anything to its left, in  $\mathcal{H}_l$ . Next we show that  $E_\lambda^j(\gamma_l) \subset T_{s_j}^{l-j}$ .

By construction  $\bar{\gamma}_l$  consists of two pieces. The first piece runs from  $E_\lambda^n(w_{l-1})$  to the inner boundary of the annulus  $E_\lambda(B_{ln-1}^1)$  along the boundary of  $C_n$ , while the second continues to the point  $w_l$  inside  $E_\lambda(B_{ln-1}^1)$ .

By Condition v) of Definition 5.1 given in the introduction to this section, the point  $E_\lambda^{n-1}(w_{l-1}) \in T_{s_{nl-1}}^1$ , so that the preimage of the first piece of  $\bar{\gamma}_l$  under  $L_{\lambda, s_{ln-1}}$  is a subset of the boundary of  $T_{s_{ln-1}}^1$ . On the other hand, the second piece of  $\bar{\gamma}_l$  is chosen so that its preimage under  $L_{\lambda, s_{ln-1}}$  is contained inside  $T_{s_{ln-1}}^1$ . Since by construction  $E_\lambda(T_j^{i+1}) \subset T_{j+1}^i$ , it follows that  $E_\lambda^j(\gamma_l) \subset T_{s_j}^{ln-j}$  for all  $0 \leq j \leq ln-1$ .

Let  $\{v_l\} \rightarrow \infty$  be any sequence such that  $v_l \in [l, l+1]$ . From the arguments in the preceding paragraph it follows that  $\gamma(v_l) \in T_0^l \subset T_0^\infty$ , and  $E_\lambda^j(\gamma(v_l)) \in T_j^{ln-j}$  for all  $0 \leq j \leq ln$ . Therefore any convergent subsequence of the sequence  $\{\gamma(v_l)\}$  must converge to a point  $z$  such that  $E_\lambda^i(z) \in T_i^\infty$ . By Lemma 6.2 and the previous section, the only point in  $T_0^\infty$  satisfying this condition is  $z_s$ . It follows that  $\gamma$  is a path in the stable set of  $E_\lambda$  such that  $\gamma(0) = z_0$  and  $\lim_{t \rightarrow \infty} \gamma(t) = z_s$  which proves the theorem. □

We can use the same approach to prove the following:

**Corollary 6.4.** *Under the assumptions of the previous theorem  $z_s$  is accessible from  $C_i$  iff  $\mathbf{s}$  is allowable and of the form*

$$\mathbf{s} = k_i \dots k_{n-2} t_1 0 k_1 k_2 \dots k_{n-2} t_2 \dots$$

with  $t_i \in \mathbb{Z}$  for all  $i$ .

The proof of Theorem 6.1 follows similarly.

**7. An Example.** In this final section we give an example that illustrates why certain endpoints are not accessible. Suppose  $\lambda$  is chosen so that  $E_\lambda$  has an attracting 2-cycle. This occurs, for example, if  $\lambda < -e$  (see [10]). Then the kneading sequence is simply  $0^*$ . So Theorem 6.1 states that the accessible sequences assume the form  $u_1 \dots u_k 0 t_1 0 t_2 0 t_3 \dots$ . In particular, the constant sequence  $\bar{1} = 111 \dots$  is not accessible. Here is the idea behind why this is true.

Our previous results show that there are a pair of curves  $h_1$  (resp.  $h_2$ ) in  $J(E_\lambda)$  corresponding to the augmented itineraries  $\overline{0_1 0_2}$  (resp.  $\overline{0_2 0_1}$ ). These curves lie on opposite sides of  $C_1$  in  $\mathcal{H}_0$ , with  $h_1$  below  $C_1$ . Both  $h_1$  and  $h_2$  terminate at the fixed point in  $\mathcal{H}_0 - C_1$  (see [6]).

There is also a curve  $w$  that lies in  $J(E_\lambda) \cap \mathcal{H}_1$  and terminates at the fixed point in  $\mathcal{H}_1$ . The itinerary of  $w$  is  $\bar{1}$ . We will show that certain preimages of  $h_1 \cup h_2$  nest down on  $w$ , effectively preventing the endpoint of this curve from being accessible.

Consider a vertical line segment  $J$  in the far right half plane that connects the upper and lower boundaries of  $\mathcal{H}_1$ . This segment meets  $w$  in a unique point,

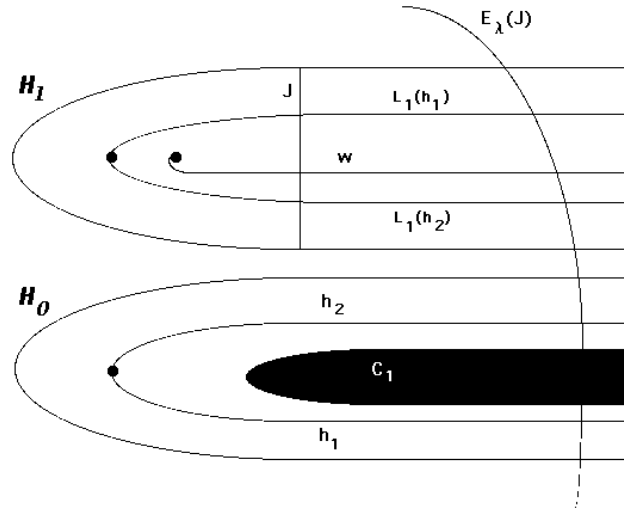
FIGURE 6. Inaccessibility of the itinerary  $\bar{1}$ .

provided that  $J$  is far enough to the right. The image of  $J$  is an arc of a circle centered at 0 that misses only  $C_1$  (see Fig. 6). The image  $E_\lambda(J)$  meets both  $h_1$  and  $h_2$  in unique points. The preimages of these points therefore have itineraries  $\overline{10_10_2}$  and  $\overline{10_20_1}$  respectively. Moreover, these preimages lie on opposite sides of  $w$  in  $J$ . Allowing the real part of  $J$  to move to the right then shows that the preimages  $L_1(h_1)$  and  $L_1(h_2)$  surround  $w$  as shown in Figure 6.

Now consider the portion of  $E_\lambda(J)$  that meets  $\mathcal{H}_1$ . This arc meets both  $L_1(h_1)$  and  $L_1(h_2)$ . Hence there are points in  $J$  that are mapped by  $E_\lambda$  onto both  $L_1(h_1)$  and  $L_1(h_2)$ . These points necessarily lie between  $w$  and  $L_1(h_1) \cup L_1(h_2)$  in  $\mathcal{H}_1$ . Hence we have another pair of curves  $L_1 \circ L_1(h_1)$  and  $L_1 \circ L_1(h_2)$  that are pinched and also nest around  $w$  inside the previous preimages. Continuing in this fashion, we find a sequence of hairs with itineraries  $1 \dots \overline{10_10_2}$  and  $1 \dots \overline{10_20_1}$  that are pinched and nest down to  $w$ . These curves form the barriers that prevent the endpoint of  $w$  from being accessible.

## REFERENCES

- [1] Aarts, J. and Oversteegen, L. The Geometry of Julia Sets, *Trans. Amer. Math. Soc.* **338** (1993), 897-918.
- [2] Ahlfors, L. and Bers, L. The Riemann Mappings Theorem for Variable Metrics, *Annals of Math.*, **72-2** (1960), 385-404.
- [3] Baker, I. N. Wandering Domains in the Iteration of Entire Functions, *Proc. London Math. Soc.* **49** (1984), 563-576.
- [4] Baker, I. N. Repulsive Fixpoints of Entire Functions, *Math. Zeitschrift* **104** (1968), 252-256.
- [5] Baker, I. N. and Rippon, P. Iteration of Exponential Functions, *Ann. Acad. Sci. Fenn.*, Series 1A Math. **9** (1984), pp. 49-77.
- [6] Bhattacharjee, R. and Devaney, R. L. Tying Hairs for the Structurally Stable Exponentials. To appear in *Ergodic Theory and Dynamical Systems*.

- [7] Blanchard, P. Complex Analytic Dynamics on the Riemann Sphere, *B.A.M.S.* **11** No.1, (1984), 85-141.
- [8] Bodelón, C., Devaney, R. L., Hayes, M., Roberts, G. and Goldberg, L., Hubbard, J. Hairs for the Complex Exponential Family. *Intl. J. Bifurcation and Chaos* **9** (1999), 1517-1534.
- [9] Carleson, L. and Gamelin, T. *Complex Dynamics*. Springer-Verlag, New York, 1993.
- [10] Devaney, R. L.  $Se^z$ ; Dynamics, Topology, and Bifurcation of Complex Exponentials. To appear in *Topology and Its Applications*.
- [11] Devaney, R. L., Fagella, N., and Jarque, X. Hyperbolic Components for the Complex Exponential Family To appear.
- [12] Devaney, R. L. and Goldberg, L. Uniformization of Attracting Basins for Exponential Maps. *Duke Mathematics Journal* **55** (1987), 253-266.
- [13] Devaney, R. L. and Jarque, X. Misiurewicz Points for Complex Exponentials *Int. J. Bifurcation and Chaos* **7** (1997), 1599-1616.
- [14] Devaney, R. L. and Krych, M. Dynamics of  $\text{Exp}(z)$ , *Ergodic Theory and Dynamical Systems* **4** (1984), 35-52.
- [15] Deville, R. E. L., Itineraries of Entire Functions. To appear in *J. Difference Eq.*
- [16] Douady, A. and Hubbard, J. Itération des Polynômes quadratiques complexes, *C.R. Acad. Sci. Paris*, **29**, Serie I-1982, 123-126.
- [17] Eremenko, A. and Lyubich, M. Yu. Iterates of Entire Functions. *Dokl. Akad. Nauk SSSR* **279** (1984), 25-27. English translation in *Soviet Math. Dokl.* **30** (1984), 592-594.
- [18] Eremenko, A. and Lyubich, M. Yu. Structural stability in some families of entire functions. *Funk. Anal. i Prilo.* **19** (1985), 86-87.
- [19] Eremenko, A. and Lyubich, M. Yu. Dynamical Properties of Some Classes of Entire Functions. *Ann. Inst. Fourier (Grenoble)* **42** no. 4, (1992), 989-1020.
- [20] Fatou, P., Sur l'itération des fonctions transcendentes Entières, *Acta Math.* **47** (1926), 337-370.
- [21] Goldberg, L. R. and Keen, L. A Finiteness Theorem For A Dynamical Class of Entire Functions, *Ergodic Theory and Dynamical Systems* **6** (1986), 183-192.
- [22] Julia, G. Iteration des Applications Fonctionnelles, *J. Math. Pures Appl.* (1918), 47-245.
- [23] Mayer, J. An Explosion Point for the Set of Endpoints of the Julia Set of  $\lambda \exp(z)$ , *Ergodic Theory and Dynamical Systems* **10** (1990), 177-184.
- [24] McMullen, C. Area and Hausdorff Dimension of Julia Sets of Entire Functions. *Trans. A.M.S.* **300** (1987), 329-342.
- [25] Misiurewicz, M., On Iterates of  $e^z$ , *Ergodic Theory and Dynam. Syst.* **1** (1981), 103-106.
- [26] Sullivan, D., Quasiconformal Maps and Dynamical Systems I: Solutions of the Fatou-Julia Problem on Wandering Domains. *Ann. Math. (2)* **122** (1985), 401-418.

*E-mail address:* bob@bu.edu